

A3H

General Description

Mercury slip ring enjoys the same performance just like other electrical sliprings, both of them are a device which could provide 360 degree rotations to transmit signal and power between stator side and rotor side of different industry equipments. No doubt, mercury slip ring just take advantage of mercury as a conductive media, which only could transfer current and signal via liquid metal under normal temperature status. This kind of slip ring has the main feature of strong stability, high precious signal and no noise. Meanwhile, compared with the traditional mechanical sliprings, this rotary connector is smaller size, easier installation and free maintenance, etc. Mercury slip ring provides the most scientific, economical and profitable rotary solution for various application industries.

Features:

1. High work speed & big current
2. Less than 1mΩ contact resistance, no noise
3. Compact structure, easy installation and smooth operation
4. Free maintenance and more durable than traditional slip ring
5. Apply to any rotating device to transmit various signal and power
6. Non-mercury slip ring is optional (Conform to CE, RoHs certification)
7. Stainless steel and aluminum alloy housing is optional
8. Contact pin and lead wire installation is optional

Application:

1. Rotating table, rotating camera and rotary lamp box
2. Cable wheel, winding machine
3. Resistors cutting machine
4. Robot arm
5. Wind turbine generator
6. Medical equipment, spinning LED sign board
7. Manufacturing and handling control machine



Notice:

1. Not exceed the max temperature 60℃ (140°F), ambient temperature + self heating.
2. Vertical mounting and storage should keep the U P in the up direction.
3. Mounting into a shaft should keep no eccentricity.
4. Do not solder on the connector and terminal.
5. Connect the connector on the terminal only a few times, losing connection will cause heating when apply electrical power.
6. Vibration will cause service life shorter.
7. The rotary connector can be mounted by the body or plastic collar, but it can not carry mechanical loads. Another end should be connected floating hold by electric wire.
8. The uppers notice should be kept, otherwise, it will cause the rotary connector failure or shorten service life.

Specification:

Specification	
Product Model	A3H
Circuits/Current	3 circuits @ 30A
Work Voltage	250VAC/DC
Max Frequency	200MHz
Max Work Speed	1200RPM
Work Temperature	-30 C - +60 C
Torque	400gm
Insulation Resistance	Greater than 25MΩ
Remarks: Transferring micro voltage, current, EMF, thermocouple, strain gauge, audio, video, high frequency signal, etc.	

Drawing:

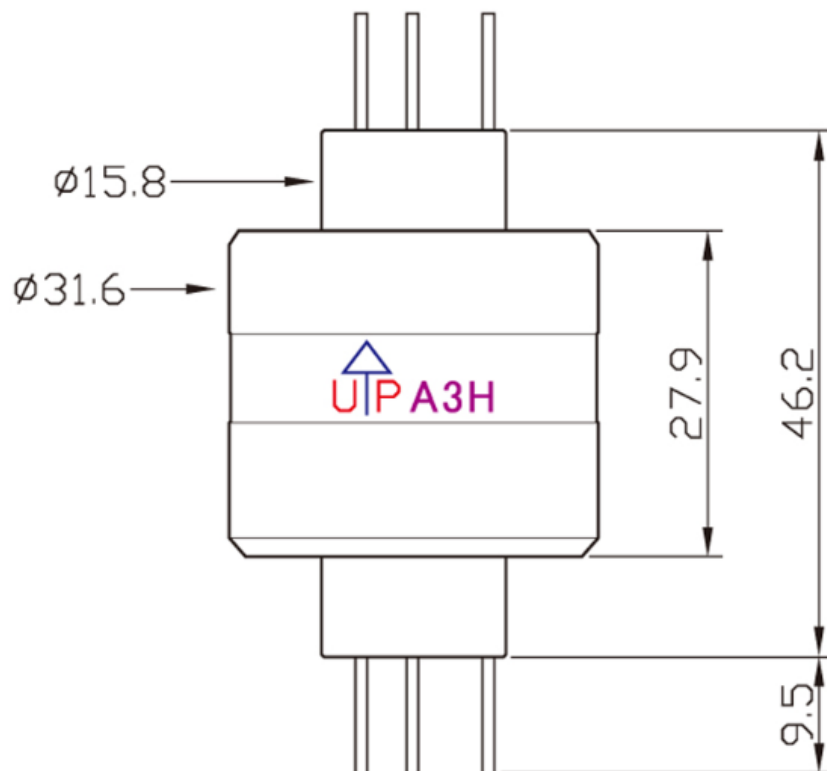

If you have specific customized requirement, please feel free to consult us so that our sales engineer could recommend the most suitable product to you for you reference.